



Technical Service

800 USG.4YOU

Web Site

usg.com

Samples/Literature

888 874.2450

Samples/Literature E-mail

samplit@usg.com

Samples/Literature/Fax

888 874.2348

Customer Service

800 950.3839

Product Information

See usg.com for the most up-to-date product information.

Metric Specifications

USG Corporation, through its operating subsidiaries, will provide metric conversions on its products and systems to help specifiers match metric design sizes. In addition, some products are available in metric dimensions from selected manufacturing plants. Refer to SA100, *Fire-Resistant Assemblies*, for additional information and a Table of Metric Equivalents.

Trademarks

The following trademarks herein are owned by United States Gypsum or a related company: AVP LITE, AQUA-TOUGH, ASTRO, BRIO, CELEBRATION, CLIMAPLUS, DIAMOND, DUROCK, DURABOND, EASY SAND, ECLIPSE, FIBEROCK, FIRECODE, FRESCO, FROST, IMPERIAL, MIDWEIGHT, MOLD TOUGH, ORION, PLUS 3, RADAR, SANDRIFT, SHEETROCK, SUMMIT, USG. THERMAFIBER is a trademark of Thermafiber LLC. LEED is a registered trademark of the U.S. Green Building Council.

Notice

We shall not be liable for incidental and consequential damages, directly or indirectly sustained, nor for any loss caused by application of these goods not in accordance with current printed instructions or for other than the intended use. Our liability is expressly limited to replacement of defective goods. Any claim shall be deemed waived unless made in writing to us within thirty (30) days from date it was or reasonably should have been discovered.

Note

All products described here may not be available in all geographic markets. Consult your local sales office or representative for information.

Safety First!

Follow good safety/industrial hygiene practices during installation. Wear appropriate personal protective equipment. Read MSDS and literature before specification and installation.



Protection from moisture
damage through each phase
of a building's lifecycle



Moisture-Resistant Assemblies



When it comes to moisture and mold, the ultimate goal is managing risk. It is crucial to manage moisture during a building's design, construction and maintenance lifecycle, because without moisture, mold cannot grow.

Moisture is the easiest and most cost-effective component to control. Although mold spores and nutrients must also be available for mold to develop, they are found everywhere and cannot be eliminated from most spaces without expensive clean room equipment.



Avoiding Moisture Problems

User's Guide

This brochure provides:

- Information about how to avoid damage from moisture and mold
- Resources to learn more about moisture and mold resistance
- A performance selector and design details that help you select the appropriate products and systems for wet and intermittently wet locations

	Pages	
Understand Your System	4	Overview Applications Components Performance Testing
Select Your System	14	Performance Selector
Design Your System	15	Design Details Good Design Practices
Specify Your System	25	Application Guide Specifications
For More Information		Technical Service 800 USG.4YOU Web Sites usg.com getmoldfacts.com

Overview

Moisture exposure can occur during all phases of the construction process and throughout the building lifecycle because of condensation, roof and pipe leaks, gross water penetration of the facade, and natural disasters. USG provides the industry's most comprehensive information regarding best practices to reduce the risk of moisture damage.

Products alone cannot control moisture or prevent mold. All products become susceptible to mold growth under unfavorable conditions. The EPA has found that mold will grow on stainless steel and glass—in fact, mold can grow on virtually all surfaces, given the right conditions.

The Tile Council of North America has defined two types of areas that are exposed to potential moisture damage:

Limited Water Exposure

Tile surfaces that are subjected to moisture or liquids but do not become soaked or saturated due to the system design or the time exposure. Examples include: residential bathroom floors and foyers, residential bathroom vertical surfaces including tub and shower surrounds, and residential kitchens and bathroom countertops.

Wet Areas

Surfaces that are either soaked, saturated, or regularly and frequently subjected to moisture or liquids (usually water), such as gang showers, tub enclosures, showers, laundries, saunas, steam rooms, swimming pools, hot tubs, and exterior areas.

Applications

The majority of moisture problems originate with water leaks—wet equipment and components; poor roofing, exterior flashing details or installation; plumbing or HVAC systems; poor site drainage; and flooding.

While it is important to control moisture exposure within the building, there are certain areas where it is clearly essential to use water-durable products, such as tub and shower areas, swimming pools, and kitchen counters.

A systems approach to managing water is the most effective strategy for controlling moisture and minimizing the growth of mold. Since mold occurs naturally everywhere in our environment, it is important to know how construction practices can affect moisture management.

The chart below illustrates how moisture affects building products and systems during all stages of the construction cycle. Controlling moisture through careful design, good construction practices and proper maintenance will help eliminate mold growth.

Moisture- and mold-resistant products	Manufacturing	Remove moisture from products during manufacture. Introduce safe and effective products to enhance moisture and mold resistance. Designate correct areas for use.
Moisture intrusion in structure	Design	Create building exteriors—roof, cladding, doors and windows—with multiple barriers to water intrusion. Avoid trapping moisture by providing paths for drainage and drying.
Moisture exposure during transportation and storage	Distribution	Protect inventory from water exposure, ensuring that materials are delivered dry to job sites. Properly store materials at distribution center and jobsite.
Moisture exposure during construction	Construction	Cover structures open to the elements during construction to shut out weather. Install building materials when weather protection is in place. Review product limitations, handling recommendations and warranties.
Drying building materials	Construction	When moisture is introduced, for example when pouring cement or painting, maintain ample ventilation and use special drying equipment where needed to remove moisture.
Moisture exposure after construction	Maintenance	Treat water infiltration from any source with the same urgency as fire protection. Stop leaks as soon as they are discovered. Properly dry, replace and repair. Inspect and repair roofs, windows and all caulking. Maintain all HVAC equipment.

Components

Moisture-resistant systems have been comprehensively tested for fire resistance and moisture intrusion. Substitutions of any of the components are not recommended or supported by USG. Refer to the appropriate product material safety data sheet for complete health and safety information.

Tile Backerboard

DUROCK® Brand Cement Board

- Strong, water-durable tile base for wet areas, exterior tile and thin brick
- Ideal underlayment for tile on floors and countertops in new construction and remodeling
- Low thermal and hygrometric expansion helps prevent cracking; high flexural strength resists bending to prevent finish cracking
- Will not swell, soften, decay, delaminate, or disintegrate in water
- 1/2" board is one-fourth the weight (3 psf) of a conventional 1" thick metal lath and portland cement plaster system
- Refer to product submittal sheet CB399 for more information

FIBEROCK® Brand Aqua-Tough™ Tile Backerboard

- Water-resistant through the core for use in intermittently wet areas, including tub surrounds
- Designed for wall assemblies in high-traffic areas where moisture, mold and fire resistance are especially important
- Suitable for use as a painted surface adjacent to tile areas and exterior ceiling board
- Made from 95% recycled materials
- Refer to product submittal sheet F134 for more information

Underlayment

DUROCK® Underlayment

- Use for floors and countertops (applies directly over old substrate on countertops to save time)
- Nominal 5/16" thickness helps eliminate transition trim when abutting carpet or wood flooring, and helps minimize level variations with other finish materials
- 4' x 4' size is easy to handle and helps cut down on waste
- Refer to product submittal sheet CB399 for more information

FIBEROCK® Aqua-Tough™ Underlayment

- Water and indentation resistance for all residential underlayment needs, including intermittently wet areas
- Use under resilient flooring, ceramic and vinyl tile, carpeting, hardwood flooring and laminate flooring
- Uniform water-resistant composition helps prevent problems associated with plywood, OSB and lauan underlayments
- Made from 95% recycled materials
- Refer to product submittal sheet F103 for more information

Sheathing**FIBEROCK® AQUA-TOUGH™ Sheathing**

- Outperforms paper- or glass-mat-faced gypsum sheathing
- Strong and water durable, with a 12-month exposure warranty
- Refer to product submittal sheet F135 for more information

SHEETROCK® Brand Gypsum Sheathing

- Water-resistant gypsum core encased in specially formulated black water-repellent paper on both sides and long edges
- Weather resistant, water repellent, fire resistant and low applied cost
- Exposure to the elements is limited to 30 days
- Economical choice for brick veneer exterior curtain wall construction and conventional stucco systems
- Refer to SA927, *Gypsum Panels and Accessories*

Exterior Soffit**SHEETROCK® Exterior Ceiling Board**

- Ideal weather-resistant and sag-resistant surface material for sheltered exterior ceiling areas
- Specially treated gypsum core encased in treated water-repellent paper
- Residential uses include open porches, breezeways, carports, and exterior soffits
- Refer to product submittal sheet WB1152 for more information

FIBEROCK® AQUA-TOUGH™ Interior Panels

- Water resistant through the core
- Mold resistant
- Superior fire resistance and exceptional surface burning characteristics
- Outperforms paper-faced or glass mat faced panels in abuse resistance
- Refer to product submittal sheet F135 for more information

Interior Panels**SHEETROCK® MOLD TOUGH™ Gypsum Panels**

- Designed specifically for use in interior areas such as bathrooms, basements, and in areas with high humidity and incidental moisture
- Uses proprietary technology for enhanced mold resistance
- Refer to product submittal sheet WB2390 for more information

FIBEROCK AQUA-TOUGH Interior Panels

- Smooth, paintable surface that can also be finished with ceramic tile
- Water, mold and fire resistant
- Made from 95% recycled materials
- Refer to product submittal sheet F135 for more information

Shaft Wall**SHEETROCK® MOLD TOUGH™ Gypsum Liner Panels**

- Water resistance and enhanced mold resistance
- For use in shaft wall and area separation wall systems
- Refer to product submittal sheet WB2389 for more information

Components

Related Products

DUROCK™ Interior Tape

- Alkali-resistant glass-fiber construction
- For use with FIBEROCK and DUROCK underlayment and tile backerboard products
- Reinforces joints and corners in interior tile or thin-brick applications
- Refer to product submittal sheet ES338 for more information

DUROCK™ Wood and Steel Screws

- Corrosion-resistant coating
- Available for wood and steel framing
- Refer to product submittal sheet CB400 for more information

DUROCK™ High-Performance Tile Mastic

- High-performance, multi-purpose adhesive for all types of ceramic and stone (except moisture-sensitive marble)
- Superior water resistance and tile bond strength
- Excellent sag resistance
- Refer to product submittal sheet CB472 for more information

DUROCK™ Multi-Purpose Tile Mastic

- High-performance, multi-purpose adhesive for large-body ceramic, porcelain and stone tile
- Excellent sag resistance, water resistance and tile bond strength
- Refer to product submittal sheet CB474 for more information

DUROCK™ Commercial Grade Tile Mastic

- High-performance commercial adhesive for all types of ceramic and stone (except moisture-sensitive marble)
- Excellent vertical grab for wall and ceiling tiles
- Refer to product submittal sheet CB471 for more information

DUROCK™ Latex-Modified Flexible Thin-Set High-Performance Mortar

- High-performance mortar for interior or exterior installations to set ceramic, porcelain, granite, slate, marble and limestone
- Good freeze/thaw stability
- Refer to product submittal sheet CB475 for more information

DUROCK™ Latex-Modified Flexible Medium-Set High-Performance Mortar

- Premium mortar to set large body tile and stone for interior and exterior applications
- Good freeze/thaw stability
- Superior durability
- Refer to product submittal sheet CB476 for more information

DUROCK™ Latex-Modified Multi-Purpose Mortar

- Multi-purpose mortar to set tile and stone for interior and exterior applications
- Superior durability
- Suitable for vertical and horizontal installations
- Refer to product submittal sheet CB477 for more information

DUROCK™ Latex-Modified Sanded Tile Grout

- High early strength and fast setting time
- Superior strength and durability for a variety of tiles
- Freeze/thaw resistant
- Refer to product submittal sheet CB478 for more information

DUROCK™ Latex-Modified Unsanded Tile Grout

- High early strength and fast setting time
- Superior strength and durability for a variety of tiles
- Freeze/thaw resistant
- Refer to product submittal sheet CB479 for more information

Performance Testing

Testing provides a basis of comparative performance results under controlled lab conditions. This does not mean that the test will accurately represent the mold performance of building materials in actual end use. Unsuitable project conditions during storage, installation and after completion can introduce moisture to building materials and cause mold.

Testing Methods

All USG products and systems undergo exhaustive testing to ensure that they meet exacting standards. USG's products are Classified as to fire resistance and fire-hazard properties. As part of this protocol, Underwriters Laboratories (UL) periodically audits production of these materials to ensure compliance with necessary properties. UL is an independent, not-for-profit product safety testing and certification organization that has tested products for public safety for over a century.

Products are manufactured and tested in accordance with ASTM standards. ASTM International is one of the largest voluntary standards development organizations in the world, and is a trusted source for technical standards for materials, products, systems, and services.

Measuring the performance of building systems exposed to moisture is difficult. Existing tests examine products under artificially created, static conditions. Building systems experience dynamic conditions where steady-state conditions are rarely achieved.

Currently, there are no standardized tests for reliably determining how various building materials may resist moisture damage or mold growth over time.

In the absence of specific tests for the broad category of construction products, the industry uses ASTM C473 and D3273. ASTM C473 measures water absorption of panels as a percentage of weight. ASTM D3273 measures resistance to mold growth. These test results do not represent definitive installed performance in specific project conditions.

USG is actively working with academic and industry testing leaders to develop a new test method that more closely approximates real-life conditions.

Moisture/Mold

The best way to minimize damage from moisture and mold is to minimize or eliminate exposure to water before, during and after construction. In all cases where moisture intrusion occurs, eliminate all sources of moisture immediately.

The use of products that are specially engineered to resist water and moisture can also help reduce moisture intrusion. DUROCK cement board and DUROCK underlayment both provide a strong, water-durable base that will not swell, soften, decay, delaminate or disintegrate in water. FIBEROCK interior panels, tile backerboard and underlayment are water-resistant through the core for use in intermittently wet areas. SHEETROCK gypsum sheathing is water-resistant, with a water-repellent paper on both sides and long edges. SHEETROCK exterior ceiling board is weather- and sag-resistant, with a treated water-repellent paper. SHEETROCK MOLD TOUGH gypsum panels have a moisture- and mold-resistant gypsum core encased in moisture- and mold-resistant, 100% recycled face and back papers. SHEETROCK MOLD TOUGH gypsum liner panels have water-resistant facings, moisture- and mold-resistant paper and a water-resistant core.

When used in conjunction with good construction practices, these products will minimize, but not eliminate, the risk of moisture damage.

For more information on moisture control and mold, see the following:

New York City Department of Health
www.ci.nyc.ny.us/html/doh

United States Environmental Protection Agency
www.epa.gov

Moisture, Mold, and Construction Practices
WB2317

Moisture Control: System Solution to Prevent Mold
WB2325

Sustainability

The LEED® (Leadership in Energy and Environmental Design) program is a guideline for building solutions established by the U.S. Green Building Council (USGBC). LEED’s mission is to transform the building industry by establishing a common standard of measurement to define what constitutes a “green building.” To this end, LEED provides a framework for assessing building performance and meeting sustainability goals. This framework assigns points for certain sustainability criteria, such as sustainable site development, water savings, energy efficiency, materials selection and indoor environmental quality.

Specific products cannot be LEED-certified, because there are many contingent factors on each project that must be considered. However, certain products may assist you in obtaining LEED points for your design solution. For example:

USGBC LEED Credits

Construction Waste Management	MR 2	
	2.1	Divert 50% of project waste (by weight) from landfill (1 point)
	2.2	Divert another 25% of project waste (by weight) from landfill (1 point)
Recycled Content	MR 4	
	4.1	If 25% of project materials by weight have 20% post-consumer or 40% post-industrial (1 point)
	4.2	Another 25% of project materials (1 point)
Local/Regional Materials	MR 5	
	5.1	If 20% of project materials are manufactured within 500 miles (1 point)
	5.2	If raw materials for above products are obtained within 500 miles of manufacturing (1 point)
Low-Emitting Materials	EQ 4	
	4.2	Drywall installation less than 200g/L per Green Seal, Table 5 (1 point)

Performance Testing

The following chart lists the products in USG moisture-resistant systems that may be eligible for LEED points. But using products with a high recycled content is only one part of the equation. Another key measure of sustainability is embodied energy, or the total energy required to produce a particular material or building component and get it to a building site. For example, if you use wallboard with a high recycled content but need to ship it across the country, the embodied energy costs of transportation may outweigh the environmental advantage of using a recycled product. It may be more environmentally sound to ship natural gypsum wallboard products from a plant close to a job site.

USGBC LEED Credits Product Family	MR 4.1 and 4.2				EQ 4		MR 5.2
	Post-Consumer	Post-Industrial	Embodied Energy ^{a,b}	Density lbs./cu. ft.	VOC ^c	Mfg. Efficiency	Raw Materials (% by weight)
SHEETROCK Panels - percent varies across 23 plants nationwide ^d	~5%	0%-95% 36.5% ave	3.6 MJ/kg	43-50	none	95+%	95% gypsum, 5% paper, 1% starch; special panel with wax and glass fiber
DUROCK Cement Board	0	20%	10 MJ/kg	72			portland cement and fly ash
FIBEROCK Panels ^d	10%	85%	5 MJ/kg	55	none	95%	85% FGD gypsum (barged 250 miles), 10% cellulose (local), and 1% starch (local)
Paper Tape	0	0	.6 MJ/kg		none	95+%	paper
Glass Fiber Tape	0	0					fibrous glass (continuous filament)
Paper Faced Bead	0	25%	40.8 MJ/kg		none		steel, paper, and non-solvent organic adhesive
Metal Bead	0	25%	34.8 MJ/kg		none		steel
Joint Compound—Setting Type	0	0	3 MJ/kg	100	none	98%	plaster of paris, limestone and mica

For more information on USGBC and LEED, visit the following web sites:

U.S. Green Building Council
usgbc.org

Leadership in Energy & Environmental Design
usgbc.org/leed/leed_main.asp

Notes

(a) Megajoules per kilogram. (b) Transportation of gypsum board accounts for over 10% of the board's embodied energy, while mining accounts for less than 1%. (c) Section 01350 of the Material Specifications adopted by the Collaborative for High Performance Schools (CHPS) for VOC emissions. (d) USG uses more recaptured (FGD or flue gas desulfurization) gypsum than any other wallboard supplier—over 3 million tons in 2003. Based on current operations, all FIBEROCK Brand panels use FGD gypsum, but the FGD gypsum content of SHEETROCK Brand panels changes from plant to plant and even day to day at any one plant, due to availability. The recycled contents above are approximate, based on plant averages for 2002. Most of the power plants that produce recaptured gypsum are east of the Mississippi River. While FGD gypsum is not available everywhere in North America, USG does have plants strategically located to meet your needs. Evaluation should be made for each job on the benefits of using FGD instead of natural gypsum.

Testing Results

ASTM D3273^a

A “0” rating on D3273 means excessive mold growth on gypsum wall or ceiling panel surfaces, while a “10” rating indicates that no mold grew on the panel. This grade is determined by inspecting the panel with a microscope and comparing the findings with standardized photographs of allowable growth for each score level. With this stringent method, a panel may not receive the top “10” rating even if mold growth is invisible to the naked eye.

This ASTM lab test may not accurately represent the mold performance of building materials in actual use. Given unsuitable project conditions during storage, installation or after completion, any building material can be overwhelmed by mold. To manage the growth of mold, the best and most cost-effective strategy is to protect building products from water exposure during storage and installation and after completion of the building. This can be accomplished by using good design and construction practices.

	Panels	Rating
Drywall	1/2" SHEETROCK® MOLD TOUGH™ (FIRECODE® C Core gypsum panels only)	10
	5/8" SHEETROCK® MOLD TOUGH™ gypsum panels, including FIRECODE® Core FIRECODE® C core and AR	10
	3/4" SHEETROCK® MOLD TOUGH™ ULTRACODE® Core	10
	SHEETROCK® MOLD TOUGH™ gypsum liner panels	10
	FIBEROCK® AQUA-TOUGH™ interior panels	10
Backerboard	DUROCK® cement board	10
	FIBEROCK® AQUA-TOUGH™ underlayment	10
	FIBEROCK® AQUA-TOUGH™ underlayment	10
Sheathing	FIBEROCK® AQUA-TOUGH™ sheathing	10
Ceilings	ASTRO™, BRIO™, FRESCO™, FROST™, SANDRIFT™ and SUMMIT™ CLIMAPLUS™ panels, and select ECLIPSE™ CLIMAPLUS™ panels	10

Typical Physical Properties

Property	ASTM Test	DUROCK Cement Board	DUROCK Underlayment	SHEETROCK MOLD TOUGH Gypsum Panels		FIBEROCK AQUA-TOUGH Tile Backerboard	FIBEROCK AQUA-TOUGH Interior Panels	
		1/2"	5/16"	1/2"	5/8"	1/2"	1/2"	5/8"
Weight—psf	C473-00	3	2	1.6	2.2	2.6	2.6	2.9
Surface burning characteristics—flame/smoke	E84	0/0	5/0	20/0	20/0	5/0	5/0	5/0
Thermal "R"/k value	C177	0.26/1.92	0.16/1.92	0.45	0.56	0.41/1.214	0.41/1.214	0.51/1.214
Min. bending radius ^b —ft.	C473-00	8	—	12	18	25	25	30
Edge		square	square	tapered	tapered	square	tapered	tapered

Notes

(a) Where K = Btu – in./hr. – °F – sq. ft. and R = hr. – °F – sq. ft./Btu. (b) Requires special framing. Details available on request. For Aqua-Tough, bending two 1/4" pieces successively permits radii shown for 1/4" gypsum board.

Performance Selector

Exterior

All details, specifications, and data contained in this literature are intended as a general guide. These products must not be used in a design or construction of any given structure without complete and detailed evaluation by a qualified structural engineer or architect to verify suitability of a particular product for use in the structure.

Application	Function	Finish	Water Barrier Required	Product	ARL Reference
Exterior soffit ^a	Commercial/residential exterior soffits	Direct-apply finish		DUROCK Cement Board	SA934
		Lay-in tile		Gypsum Lay-In Panel	SC2000
		Paint		FIBEROCK AQUA-TOUGH Interior Panel	SA934
		Paint		SHEETROCK Exterior Gypsum Ceiling Board	SA934
		Metal lay-in panel		CELEBRATION™ Metal Ceiling Panels	SC2000
Exterior wall sheathing ^a	Residential/commercial exterior walls	Brick	•	FIBEROCK AQUA-TOUGH Sheathing/ SHEETROCK Gypsum Sheathing	SA700
		Conventional stucco	•	FIBEROCK AQUA-TOUGH Sheathing/ SHEETROCK Gypsum Sheathing	SA700
		Wood siding	•	FIBEROCK AQUA-TOUGH Sheathing/ SHEETROCK Gypsum Sheathing	SA700
		Metal panel	•	FIBEROCK AQUA-TOUGH Sheathing/ SHEETROCK Gypsum Sheathing	SA700
		EIFS		DUROCK Cement Board/ FIBEROCK AQUA-TOUGH Sheathing	SA700

Interior

Application	Function	Finish	Water Barrier Required	Product	ARL Reference
Interior floor	Limited water exposure underlayment	Ceramic tile		FIBEROCK AQUA-TOUGH Underlayment/ DUROCK Underlayment	SA934
	Wet	Ceramic tile	•	DUROCK Underlayment/DUROCK Cement Board	SA934
Interior wall	Dry	Paint		SHEETROCK Gypsum Panel SHEETROCK MOLD TOUGH Gypsum Panel/ FIBEROCK AQUA-TOUGH Interior Panel	SA934
		Limited water exposure cavity	Ceramic tile Paint		FIBEROCK AQUA-TOUGH Tile Backerboard FIBEROCK AQUA-TOUGH Interior Panel/MOLD TOUGH
	Wet	Ceramic tile	• ^a	DUROCK Cement Board	SA934
	Interior of exterior wall	Above grade	Paint		SHEETROCK MOLD TOUGH Gypsum Panel
Below grade furred ^a		Paint		FIBEROCK AQUA-TOUGH Interior Panel SHEETROCK MOLD TOUGH Gypsum Panel	SA934
Kitchens	Countertops	Ceramic tile	•	DUROCK Cement Board/ FIBEROCK AQUA-TOUGH Tile Backerboard	SA934
Bathrooms	Walls	Paint		FIBEROCK AQUA-TOUGH Interior Panel/MOLD TOUGH	SA934
Steam rooms or saunas ^a	Walls	Ceramic tile	•	DUROCK Cement Board	SA934
	Ceilings	Acoustical tile	•	RADAR™ Ceramic CLIMAPLUS™	SC2000
Swimming pool rooms ^a	Walls	Ceramic tile/ext. finish	•	DUROCK Cement Board	SA934
	Ceilings	Ceramic tile/ext. finish	•	DUROCK Cement Board	SA934
		Acoustical tile		RADAR Ceramic CLIMAPLUS, ORION™ 210 CLIMAPLUS	SC2000

Notes

(a) Dew Point Analysis and Vapor Retarder Analysis required. (b) See Good Design Practices, No. 3

Design Details

Interior Installation

Counter Tops

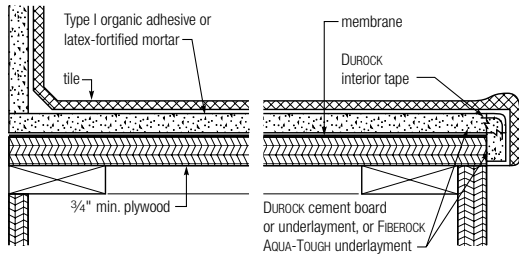

Floors, Interior—Wood or Steel Joists

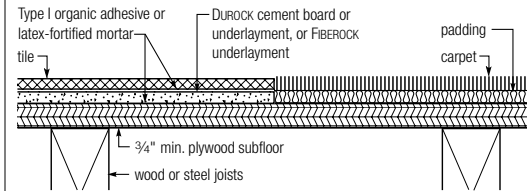

Note
For bonding cement backerboard to plywood subfloor, use Type 1 organic adhesive or latex-fortified mortar that is suitable for this kind of application. For application of various types of tiles to cement backerboard on floors or countertops, contact the tile manufacturer for the appropriate type of tile-setting mortar.

Suspended Ceiling Detail

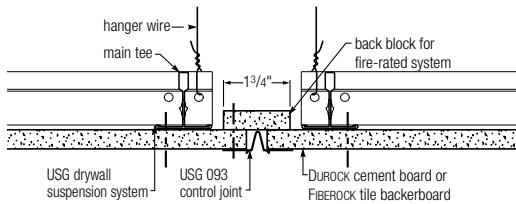

Wood Soffit Framing

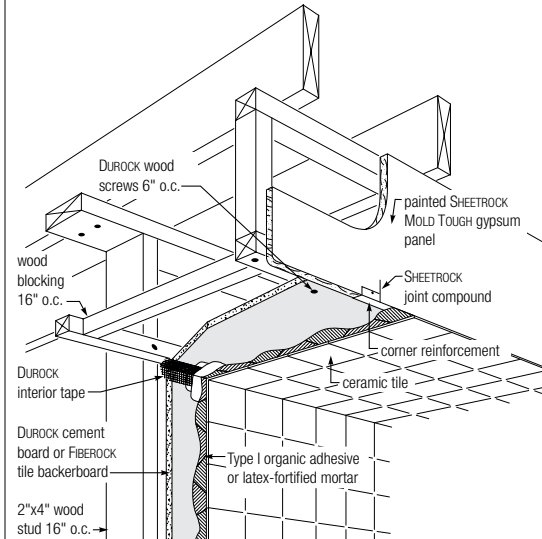

Large Shower Area

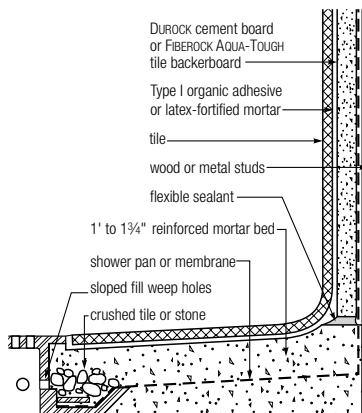

Residential Tub

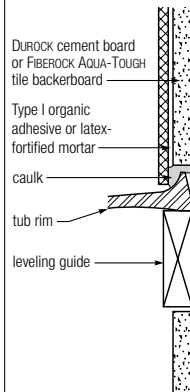

Residential Shower

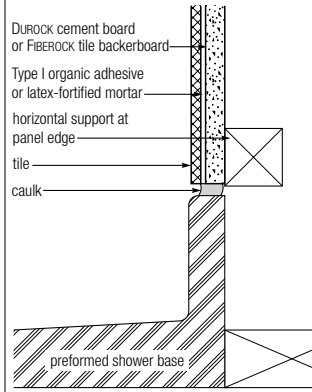

Residential Shower Wall

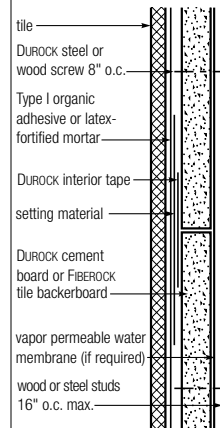

Design Details

Interior Installation

Typical Bathtub Installation

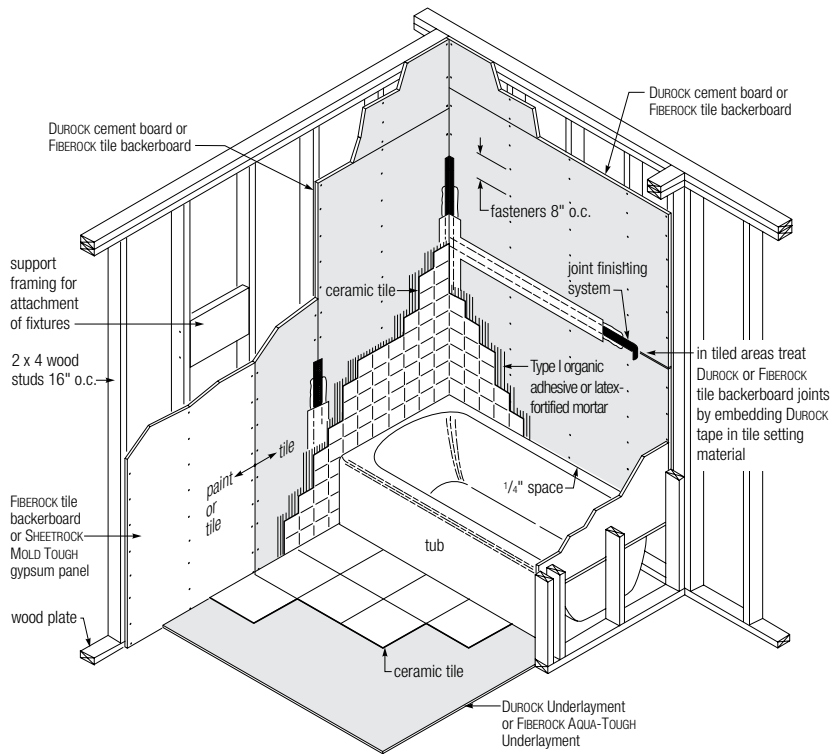

Fixture Attachment—Steel Framing

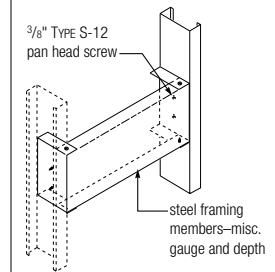
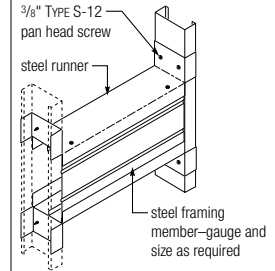

Typical Swimming Pool—Tile or Exterior Finish

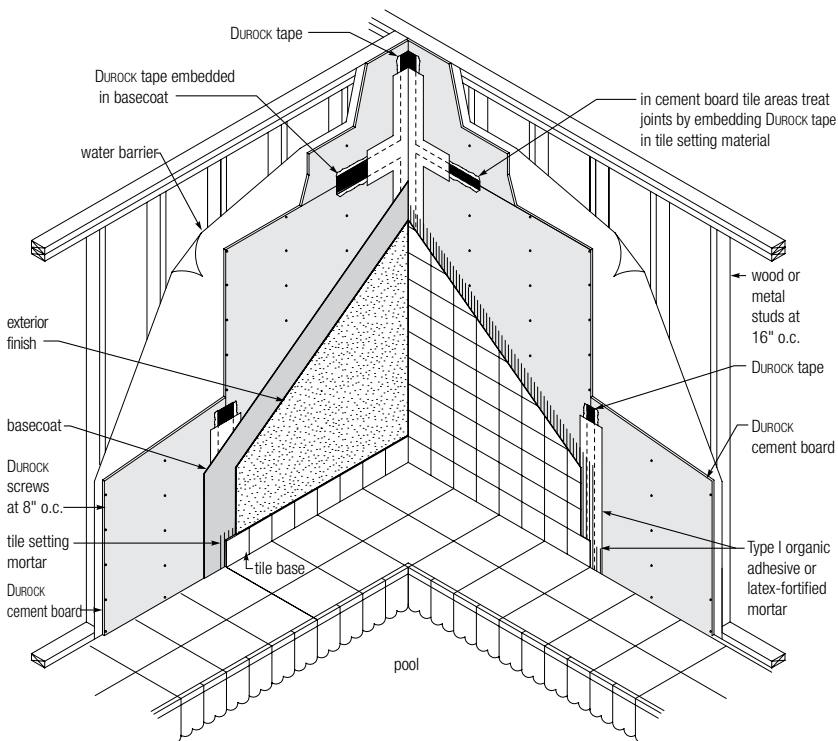

Curtain Walls

Scale: 3" = 1'-0"

Conventional Stucco

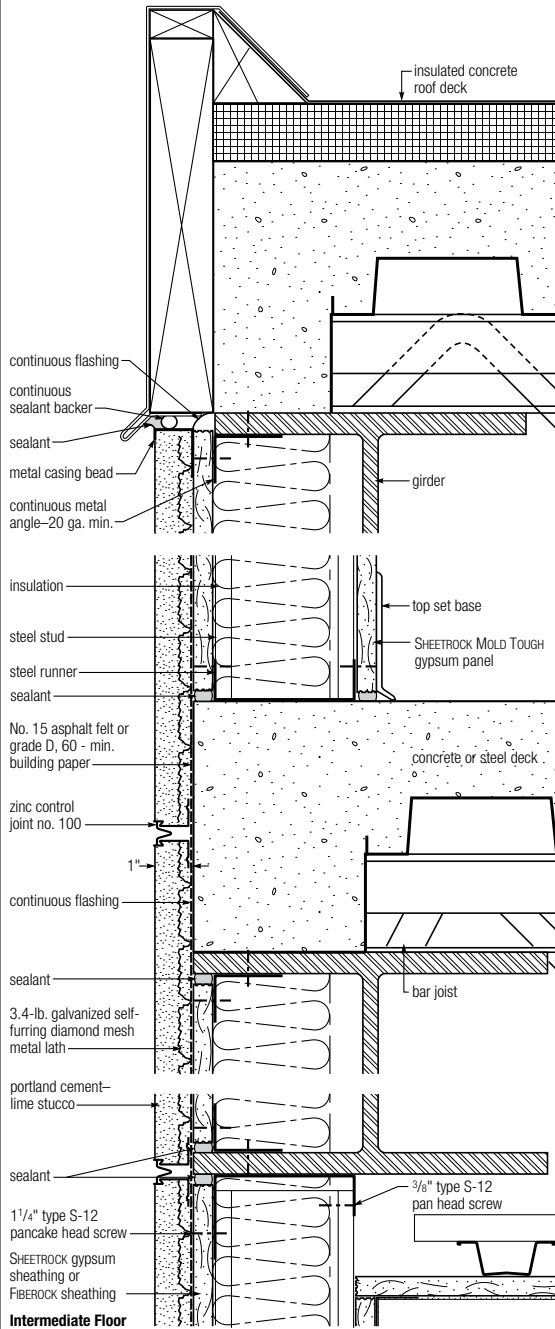

Design Details

Curtain Walls

Masonry Veneer

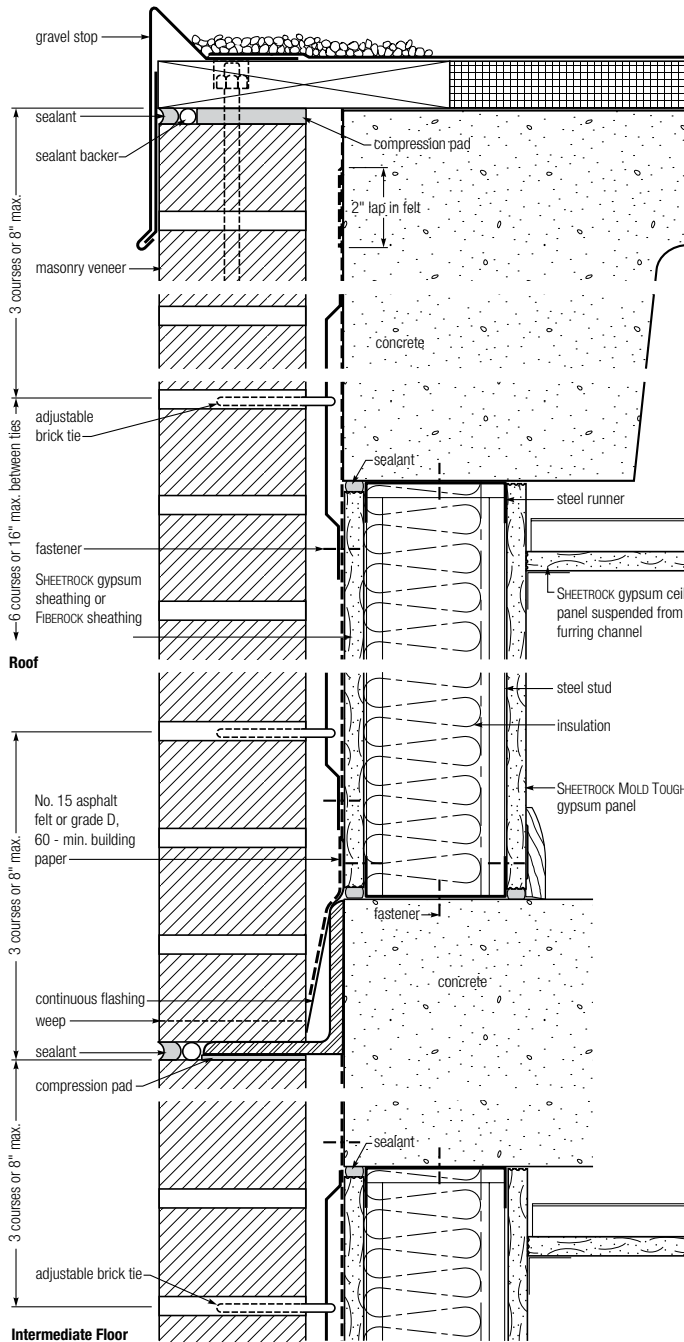

Horizontal Flashing

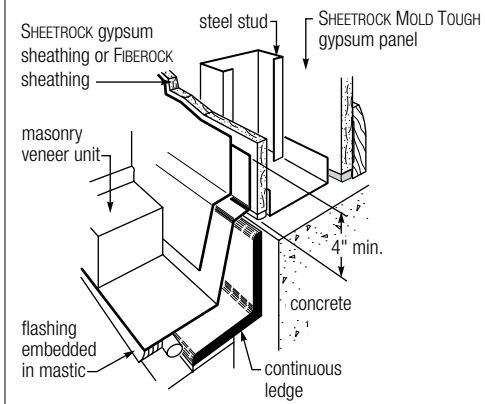

Foundation

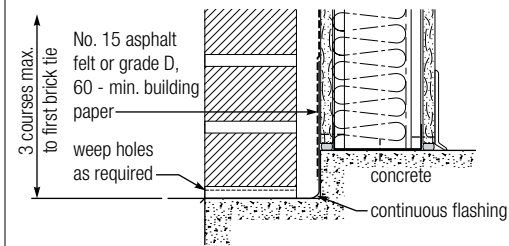

Note

Consult BIA technical note 28B, revised November 1999, for framing recommendations for brick veneer buildings.

The architect and/or structural engineer shall determine appropriate selection and placement of brick ties, flashing, weep holes, wall cavity width, masonry building requirements, mortar selection, and workmanship requirements.

Scale: 3" = 1'-0"

Furring Systems

Scale: 3" = 1'-0"

Wall—Control Joint

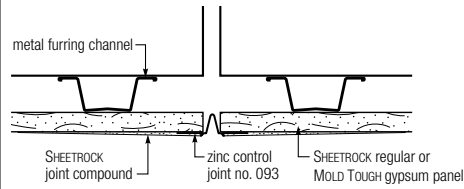

Freestanding Furring

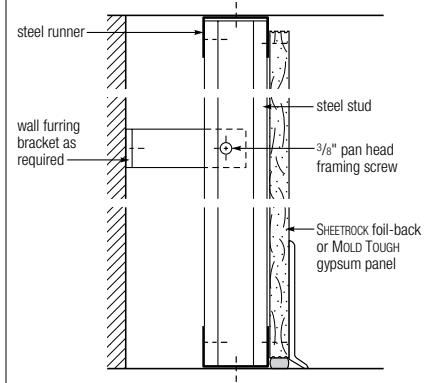

Furred Wall (for reduced shadowing and spotting)

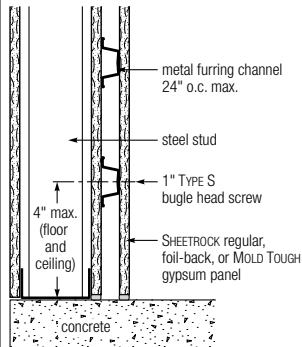

Exterior Curtain Wall

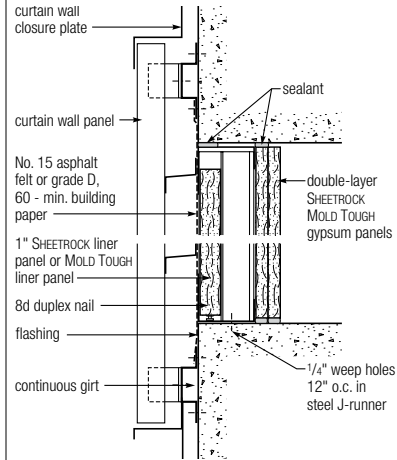

Ceiling Attachment

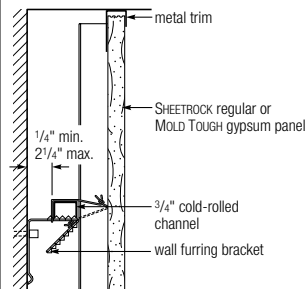

Attachment—Suspended Ceiling

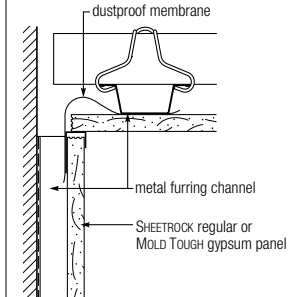

Note
For furred exterior walls below grade, use FIBEROCK AQUA-TOUGH interior panel or DUROCK cement board.

Design Details

Furring Systems

Scale: 3" = 1'-0"

Attachment—Furring at Floor

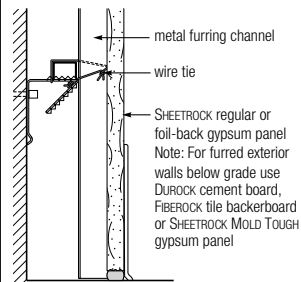

Attachment—Direct Furring

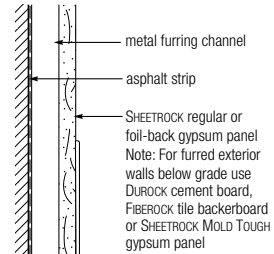

Jamb

Steel Door Frame

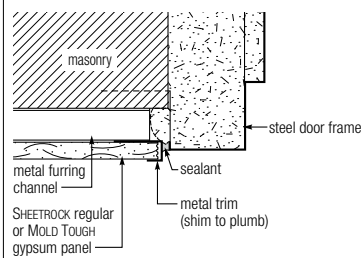

Window—Metal

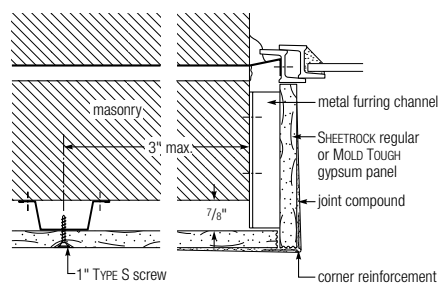

Fixture Attachment

Scale: 3" = 1'-0"

Closet Carrier

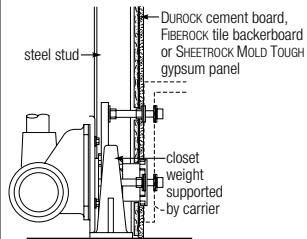

Lavatory Carrier

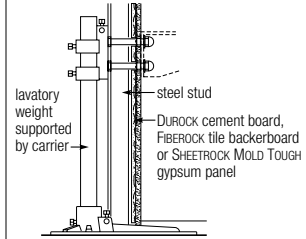

Heavy Plumber's Bracket

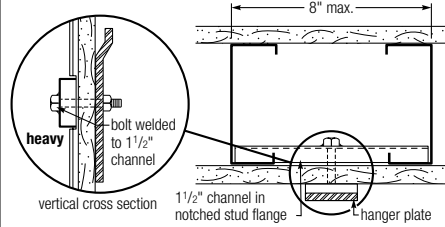

Medium

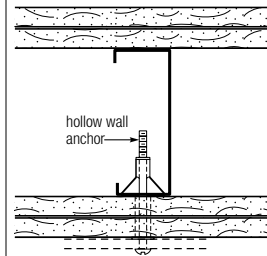

Medium Grab Bar Attachment

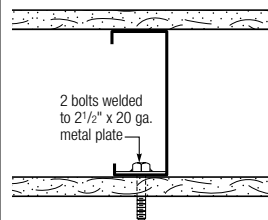

Exterior Wall and Soffit

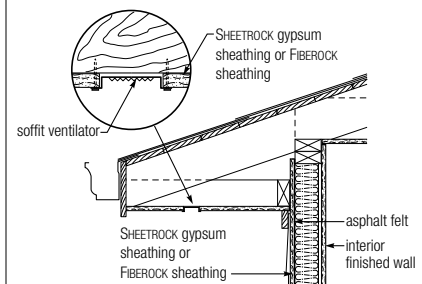

Design Details

Scale: 3" = 1'-0"

Double-Layer Panel

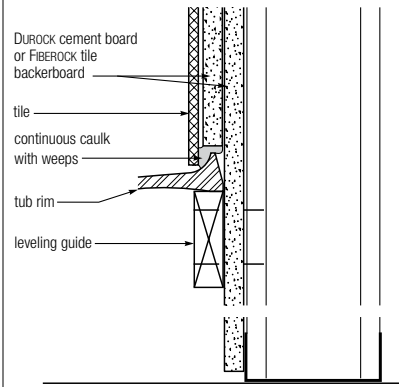

Shower Receptor

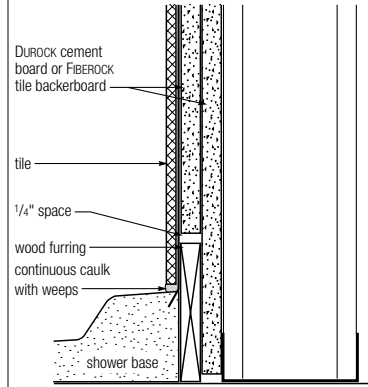

Good Design Practices

Use this section as a reference if questions arise during the design or application of USG moisture-resistant assemblies.

This section is an overview of good design, application, installation and safety concerns that should be addressed when USG's products and systems are used. This section outlines some major issues, but is not intended to be comprehensive.

These products must not be used in a design or construction without a complete evaluation by a qualified engineer or architect to verify suitability of a particular product for use in the structure. For safety considerations and material handling, please refer to Chapter 13 in *The Gypsum Construction Handbook, Centennial Edition*.

1 System Performance United States Gypsum Company conducts tests on products and systems to meet performance requirements of established test procedures specified by various agencies. Upon written request we will provide test certification for published fire, sound, structural and other pertinent data covering systems designed and constructed according to our published specifications.

Important: Substitutions of any of the components are not recommended or supported by the United States Gypsum Company.

Systems covered herein have been tested and evaluated for use as described. For other system applications, consult your local representative. Information in this publication should be used only for products of United States Gypsum Company, as physical properties of competitive products may vary. United States Gypsum Company assumes no liability for failure resulting from the use of alternative materials or improper application or installation as specified herein.

2 Expansion and Contraction Wall surfaces should be isolated with surface control joints (sometimes referred to by the industry as expansion joints) or other means where: (a) a wall abuts a structural element or dissimilar wall or ceiling; (b) construction changes within the plane of the wall; (c) tile and thin brick surfaces exceed 16'. Surface control joint width should comply with architectural practices.

Location of building control joints is the responsibility of the design professional/architect. Steel framing at building control joints that extend through the wall (with top and bottom runner tracks broken) should have 1-1/2" cold-rolled channel alignment stabilizers spaced a maximum of 5'0" o.c. vertically. Channels should be placed through holes in the stud web of the first two adjacent studs on both sides of the joint and securely attached to the first adjacent stud on either side of the joint.

Cement board and gypsum panels should be separated at all surface and building control joints. Where vertical and horizontal joints intersect, the vertical joint should be continuous and the horizontal joint should abut it. Splices, terminals, and intersections should be caulked with a sealant complying with architectural practices and sealant manufacturer recommendations. Do not apply tile or finishes over caulked sealed expansion joints. See SA700, *Exterior System Substrates*, for additional information.

Good Design Practices

3	Water Barrier	DUROCK cement board is vapor permeable and does not deteriorate in the presence of water. For interior applications, if a vapor retarder or waterproof construction is specified, a separate barrier must be applied over or behind the DUROCK cement board. For exterior applications, see SA700, <i>Exterior System Substrates</i> .
4	Swimming Pool Enclosures	DUROCK cement board may be used for the walls and ceilings around indoor swimming pools. Consideration shall be given to adequate ventilation in plenums and corrosion protection of metal hangers and framing members.
5	Soffits and Exterior Ceilings	DUROCK cement board and FIBEROCK interior panels finished with paint or textured finish may be used on properly vented soffits and ceilings with DUROCK screws spaced 6" o.c. max. A qualified structural engineer should evaluate design, including uplift bracing. Ceramic tile or thin brick may be applied to DUROCK panels.
6	Steam Rooms and Saunas	For steam rooms and saunas where temperatures exceed 120 °F for extended periods, use DUROCK cement board and dryset or latex-fortified portland cement mortar; do not use organic adhesive.
7	Air and Water Infiltration	Select flashing and sealants to provide resistance to air and water infiltration. Install flashing and sealants in a workman-like manner and in appropriate locations to maintain continuity of air/water barriers, particularly at windows, doors and other penetrations in the exterior wall. Cover all gypsum sheathing with No. 15 asphalt felt or Grade D 60 min. Building Paper to ensure water-tight construction. Apply asphalt horizontally in a shingle-like manner starting from the bottom of the wall, with 2" overlap and attached to sheathing.
8	Smooth Side/ Rough Side	DUROCK cement board has a smooth side and a rough side. Use the smooth side for mastic applications and the rough side for mortar applications.
9	Shadowing and Spotting	When the outside temperature differs considerably from the building's interior temperature, airborne dirt can accumulate on the colder regions of walls, causing "shadowing" or "spotting," particularly over fasteners and framing. This natural phenomenon occurs through no fault in the products. Where temperature, humidity, and soiling conditions are expected to cause objectionable blemishes, provide a thermal separation between the interior and exterior faces.
10	Leaching and Efflorescence	Latex leaching and efflorescence are natural phenomena which occur with the use of latex modified mortars and grouts through no fault in the products. To help protect against their occurrence, follow current industry guidelines and recommendations.
11	Vapor Retarders	Water vapor control must always be considered in the design of exterior wall systems. Humidity and temperature conditions may require the installation of a vapor retarder to prevent moisture condensation within the wall and the resulting damage. To determine the necessity and location of vapor retarders, a water vapor transmission and dew point analysis of the layered wall assembly should be conducted by a qualified engineer.
12	Corrosion Protection	All architectural components, such as anodized-aluminum window frames, trims, flashings and casings, shall be protected from alkaline building materials such as cement board, portland cement basecoats, mortars and grouts. Isolate steel from aluminum in moist environments to protect against electro-galvanic corrosion.
13	SHEETROCK Exterior Gypsum Ceiling Board	Exposed surfaces should receive two coats of good quality exterior paint. First coat: oil-based primer; second coat: either alkyd or latex exterior paint.

Application Guide

Specifications

This guide is provided to assist you in specification of USG moisture-resistant systems and assemblies. If you have additional questions or would like more information regarding this or other USG products and systems, please contact USG at 800.USG.4YOU.

Part 1: General

1.1 Scope

Specify to meet project requirements.

1.2 Qualifications

All materials, unless otherwise indicated, shall be manufactured by United States Gypsum Company and shall be installed in accordance with its current printed directions.

1.3 Delivery and Storage of Materials

All materials shall be delivered in their original unopened packages and stored in an enclosed shelter providing protection from damage and exposure to the elements. Damaged or deteriorated materials shall be removed from the premises.

Warning: Store all panel products flat. Panels are heavy and can fall over, causing serious injury or death. Do not move unless authorized.

1.4 Environmental Conditions

In cold weather and during interior finishing and tile installation, temperatures within the building shall be maintained within the range of 40 to 100 °F. Adequate ventilation shall be provided to carry off excess moisture.

A. Interior Applications

Wood framing shall approximate the moisture content it will reach in service by allowing the enclosed building to stand as long as possible prior to the application of the panel. Do not install panel when wet.

B. Exterior Applications

Finishes, leveling/skim coats and basecoats shall not be applied to panels that are wet or frozen or that contain frost. After application, and for at least 24 hours, finishes, leveling/skim coats and basecoats shall be effectively protected from rain and excessive moisture.

In cold weather and during finish applications, panel, skim or basecoat, mortar, finish material and air temperature must be at least 40 °F, and must remain at this temperature or higher for at least 24 hours after application. Hot and dry weather may affect working time of leveling/skim or basecoat and finish materials. Under rapid drying conditions, dampening or light fogging of board, leveling/skim or basecoat surface may be required to improve workability.

1.5 Framing

Steel or wood wall framing to receive panel shall be structurally sound, free from bow, and in general compliance with local building code requirements. Damaged and excessively bowed studs shall be replaced before installation of panel. Framing shall be designed (based on stud properties alone) not to exceed L/360 deflection for tile, thin brick veneer and conventional stucco, L/240 for Direct-Applied Exterior Finish Systems. Steel framing must be 20 gauge or heavier with corrosion-resistant metal coating equivalent to G60 hot-dipped galvanized. Exterior steel framing should be laterally braced.

1.6 Installation Practices

DUROCK cement board should be cut to size with carbide-tipped knife and straight edge. Power saw should be used only if equipped with a dust-collection device and a NIOSH/MSHA-approved respirator is worn.

SHEETROCK gypsum panels can be cut to size with a standard utility knife in a score-and-snap manner.

FIBEROCK panels should be cut to size using a knife and a straight edge. Power saw should only be used if it is equipped with a dust-collection device.

Contractors installing tile and tile-setting materials should always follow current ANSI specifications and TCNA guidelines.

Application Guide

Specifications

Part 2: Products

2.1 Materials

A. Tile Backerboard

1. DUROCK cement board
2. FIBEROCK AQUA-TOUGH tile backerboard

B. Underlayment

1. DUROCK underlayment
2. FIBEROCK AQUA-TOUGH underlayment

C. Gypsum Panels

1. SHEETROCK MOLD TOUGH gypsum panel
2. SHEETROCK gypsum sheathing panel
3. SHEETROCK exterior ceiling board
4. SHEETROCK MOLD TOUGH gypsum liner panel
5. FIBEROCK AQUA-TOUGH interior panel

D. USG Drywall Suspension System

1. Main Tees: Fire-Rated Heavy Duty classification 1-1/2" high x 144" long, integral reversible splice with knurled face.
DGL-26 15/16" Face
or
DGLW-26 1-1/2" Face
2. Cross Members: Fire-Rated members with knurled face.
Cross Tees: DGLW-424 cross tee 1-1/2" high x 48" long with 1-1/2" wide face. Tees must have quick release cross tee ends to provide positive locking and removability without the need for tools.
3. Accessory Cross Tees: Cross tees must have knurled faces. Cross tees have quick release cross tee ends to provide positive locking and removability without the need for tools.
DGL-224 Fire-Rated 1-1/2" high x 24" long with 15/16" face
DGL-324 Fire-Rated 1-1/2" high x 36" long with 15/16" face
DGL-424 Fire-Rated 1-1/2" high x 48" long with 15/16" face
DGL-824 Non Fire-Rated 1-1/2" high x 96" long with 15/16" face
DGLW-224 Fire-Rated 1-1/2" high x 24" long with 1-1/2" face
DGLW-424 Fire-Rated 1-1/2" high x 48" long with 1-1/2" face
4. Wall moldings: Single web with knurled face.
DGM-16 1"x 1" x 144" long wall molding.
DGCM-25 144" x 1-9/16" x 1" x 1" channel molding.

E. Joint Reinforcement

1. For DUROCK: DUROCK joint tape (alkali-resistant), 2" x 50', 2" x 250', or 4" x 150'.
2. For FIBEROCK: SHEETROCK joint tape, 2-1/16" x 75', 2-1/16" x 250', 2-1/16" x 500'.
3. For MOLD TOUGH:
 - SHEETROCK joint tape
 - SHEETROCK fiberglass drywall tape (must use a setting-type joint compound for first coat over tape)
 - SHEETROCK DURABOND setting-type or EASY SAND lightweight setting-type joint compound (20, 45, 90, 210, 300)
 - SHEETROCK joint compound (taping, topping, all purpose)

- SHEETROCK lightweight all purpose joint compound (A/P LITE)
- SHEETROCK ready-mixed joint compound (taping, topping, all purpose, multi-purpose)
- SHEETROCK PLUS 3 lightweight all purpose joint compound ready-mixed
- SHEETROCK MIDWEIGHT all purpose joint compound, ready-mixed

F. Fasteners

For DUROCK:

- DUROCK steel screws, 1-1/4" for 14 to 20 gauge steel framing; DUROCK wood screws 1-1/4" or 1-5/8" for wood framing.
- Nails (1-1/2" hot-dipped galvanized roofing nails).

For FIBEROCK:

- Corrosion-resistant screws.
- 1/4" crown staples.

G. Subfloor

(5/8") (3/4") plywood or oriented strand board (OSB), 4' x 8' sheets, exterior grade or better, exterior glue conforming with PS-1-66, T&G or back block long edges.

H. Adhesives/Mortars

Products compatible with alkaline or portland cement-based DUROCK cement board and FIBEROCK AQUA-TOUGH tile backerboard:

1. Meeting ASTM C557-73: multipurpose adhesive (for subfloor to framing attachment).
2. Meeting ANSI A136.1 Type I.
3. Meeting ANSI A118.1: dry-set mortar mixed with acrylic latex additive.
4. Meeting ANSI A118.4: latex portland cement mortar.

I. Grout

Meeting ANSI A118.6: specify type.

J. Tile

Tile shall meet ANSI A137.1.

K. Membrane

DUROCK only: #15-lb. felt or 4-mil polyethylene water barrier, if required, in accordance with local building codes.

Part 3: Execution

3.1 Floors

A. Subfloor

Apply 3/8" bead of multipurpose adhesive to center of top flange of joists. Place 5/8" min. exterior grade plywood or OSB sheets with long dimension across or parallel to wood or steel joists spaced max. 16" o.c. (For 3/4" plywood or OSB, wood or steel joists should be spaced 24" o.c.) Fasten plywood to steel joists with 1-15/16" pilot point self-drilling screws spaced as required. Fasten plywood to wood joists with adhesive and suitable nails or screws spaced as required.

B. Panel Application

Laminate 5/16" DUROCK or FIBEROCK AQUA-TOUGH underlayment to subfloor using Type 1 organic adhesive, latex- fortified mortar or dry-set mortar mixed with acrylic latex additive that is suitable for bonding cement backer board to plywood

Application Guide

Specifications

subfloor, with 1/4" square-notched trowel for mortar, 5/32" V-notched trowel for adhesive. Place underlayment with joints staggered from subfloor joints. Fit ends and edges closely but not forced together, leaving a 1/8" gap. Fasten to subfloor with 1-1/4" DUROCK wood screws or 1-1/2" hot-dipped galvanized roofing nails or corrosion-resistant screws (for FIBEROCK) spaced 8" o.c. in both directions with perimeter fasteners at least 3/8" and less than 5/8" from ends and edges. 1/2" and 5/8" DUROCK cement board or FIBEROCK AQUA-TOUGH tile backerboard—same procedure.

3.2 Walls

A. Framing

Space wood and steel framing a maximum of 16" o.c. (24" o.c. for UL Design U459 or U415). The studs of freestanding furred walls must be secured to the exterior wall with wall furring brackets or laterally braced with horizontal studs or runners spaced 4' o.c. max. Laterally brace all steel-framed walls prior to the application of joint treatment.

B. Gypsum Panel Application—Basic Single-Layer System, Treated Joints

1. Position all ends and edges of all gypsum panels over framing members, except when joints are at right angles to framing members as in perpendicular application or when end joints are backblocked.
2. Apply gypsum panels first to the ceiling and then to the walls. Extend ceiling board into corners and make firm contact with top plate. To minimize end joints, use panels of maximum practical lengths. Fit ends and edges closely, but not forced together. Stagger end joints in successive courses with joints on opposite sides of a partition placed on different studs.
3. Attach panels to framing supports by: (Standard Single Nailing Method) (Adhesive Application) (Double Nailing Method) (Power-driven Screws). Space fasteners not less than 3/8" from edges and ends of panels and drive as recommended for specified fastening method. Drive fasteners in field of panels first, working toward ends and edges. Hold panel in firm contact with framing while driving fasteners. Drive fastener heads slightly below surface of gypsum panels in a uniform dimple without breaking face paper.
4. Cut ends, edges, scribe or make cutouts within field of panels in a workmanlike manner. Gypsum board should be cut to size using a knife and a straight edge. A power saw should be used only if it is equipped with a dust collection device.
5. Install trim at all internal and external angles formed by the intersection of either panel surfaces or other surfaces. Apply corner bead to all vertical or horizontal external corners in accordance with manufacturer's directions. (Multilayer systems: see pertinent United States Gypsum Company reference.)

C. DUROCK or FIBEROCK Panel Application

After tub, shower pan or receptor is installed, place temporary 1/4" spacer strips around lip of fixture. Pre-cut board to required sizes and make necessary cut-outs. Fit ends and edges closely but not forced together, leaving a 1/8" gap. Install board abutting top of spacer strip. Stagger end joints in successive courses. Fasten boards to wood studs spaced max. 16" o.c. and bottom plates with 1-1/4" DUROCK wood screws or 1-1/2" hot-dipped galvanized roofing nails or corrosion resistant screws (for FIBEROCK) spaced 8" o.c. Fasten DUROCK cement board or FIBEROCK AQUA-TOUGH tile backerboard to steel studs spaced max. 16" o.c. and bottom runners with 1-1/4" DUROCK steel screws or corrosion-resistant screws (for FIBEROCK) spaced 8" o.c. with perimeter fasteners at least 3/8" and less than 5/8" from ends and edges. In double-layer walls where cement boards are installed over base-layer gypsum boards, apply a vapor-permeable water barrier over gypsum boards.

D. Shaft Wall System with Ceramic Tile Finish

Attach DUROCK cement board over base layer of gypsum panels with 1-5/8" DUROCK steel screws at 8" o.c. to studs. Since studs are at 24" o.c., laminate cement board to base layer of gypsum panels with a 4" wide strip of construction adhesive between studs. Apply adhesive with a 1/4" square-notched trowel.

E. Exterior Walls

Attach Durock cement board with corrosion-resistant screws spaced a maximum of 8" o.c. over framing spaced a maximum of 16" o.c. Apply a weather-resistive barrier and flashing behind the panels as required. Follow the exterior finish manufacturer's recommendations for application over Durock cement board.

**3.3
Countertops**

A. Base

Install minimum 3/4" exterior-grade plywood base across wood cabinet supports spaced maximum 16" o.c. Position ends and edges over supports.

B. Membrane

Staple-attach 15-lb. felt or 4-mil polyethylene film using 1/4" galvanized staples over plywood base.

C. Panel Application

Secure 5/16" Durock or Fiberock Aqua-Tough underlayment to plywood. Fasten to plywood with 1-1/4" Durock wood screws or 1-1/2" hot-dipped galvanized roofing nails spaced 8" in both directions and around edges; fit ends and edges closely but not forced together, leaving a 1/8" gap.

Application of 1/2" or 5/8" Durock cement board or Fiberock Aqua-Tough tile backerboard—Use same procedure.

D. Joint Finishing

1. For Durock: Prefill joints with latex-fortified mortar or Type 1 organic adhesive; completely embed Durock interior tape; and level all joints and outside corners.
2. For Fiberock: Prefill joints with latex-fortified mortar or Type 1 organic adhesive; completely embed SHEETROCK fiberglass tape; and level all joints and outside corners.

**3.4
Ceilings**

A. Framing

Ceiling joists, furring channels or strips must be spaced max. 16" o.c. Framing must be capable of supporting the total ceiling system dead load, including insulation, ceramic tile, bonding materials and cement board, with deflection not exceeding L/360 of the span. When steel framing is used, min. 20 ga. is required.

B. Panel Application

Apply 1/2" Durock cement board or Fiberock Aqua-Tough tile backerboard to framing with long dimension across framing. Center end or edge joints on framing and stagger joints in adjacent rows. Fit ends and edges closely, but not forced together, leaving a 1/8" gap. Fasten boards to steel framing with 1-1/4" Durock steel screws or corrosion-resistant screws (for Fiberock) spaced 6" o.c. and to wood framing with 1-5/8" Durock wood screws spaced 6" o.c. with perimeter fasteners at least 3/8" and less than 5/8" from ends and edges. If necessary, provide additional blocking to permit proper attachment. Edges or ends parallel to framing shall be continuously supported.

**3.5
Joint Treatment
Application**

A. For Tile and Thin Brick

Prefill all Durock cement board joints, and joints where Durock cement boards abut other panels or surfaces such as gypsum board, with tile-setting mortar or adhesive, and then immediately embed tape and level the joints.

B. For Dry Untiled Areas

For small areas where the Durock cement board will not be tiled, such as a board extending beyond the tiled area and abutting another surface, treat joints as follows. Seal Durock cement board with Durock high-performance tile mastic or Type I Ceramic Tile Adhesive. (Mix four parts adhesive with one part water.) Embed SHEETROCK joint tape over joints and treat fasteners with SHEETROCK setting-type joint compound (DURABOND® 45 or 90) applied in conventional manner.

Application Guide

Specifications

Flat trowel SHEETROCK setting-type joint compound over board to cover fasteners and fill voids to a smooth surface. Finish joints with at least two coats SHEETROCK ready-mixed joint compound. Do not apply ready-mixed or setting-type joint compound over unsealed board.

3.6 Interior Ceramic Tile Application

A. Tile Application

Plan tile layout, then spread DUROCK high-performance tile mastic with trowel recommended by tile manufacturer held at 45° angle. Apply no more adhesive than can be covered in 20-30 mins. Open time will vary according to temperature and humidity.

When applying over old ceramic tile, allow adhesive to set 10-15 mins. before applying new tile. Wall tiles may be set top down or bottom up. Press, do not slide, tiles and sheets of tile into adhesive. Maintain accurate joint alignment and spacing as tiles are positioned. Use wooden or rubber-faced beating block, tapped lightly with a mallet to level and ensure solid tile positioning. Check occasionally to ensure at least 95% adhesive transfer to back of tile. Avoid adhesive squeeze-up between tiles. It may be necessary to butter adhesive on backs of large pavers and quarry tile.

Note: Contractors installing ceramic tile should always follow ANSI Specifications and TCNA Guidelines. Do not use Type I Ceramic Tile Adhesive for the installation of button back tile, slate, marble and floor tiles over 6" x 6"; instead, use DUROCK latex-modified high performance mortar or a latex-fortified mortar.

B. Recommended Adhesive and Mortar Coverage

Recommended adhesive and mortar coverage will vary based on the substrates and notched trowel sizes commonly recommended by the tile or adhesive manufacturer.

C. Drying Time

Do not walk on floors for at least 48 hrs. unless walking boards or plywood sheets are used. To finish job, wait 24 hrs. after tile has been installed for walls and countertops, 48 to 72 hrs. for floors, before grouting.

D. Grouting

Select, prepare and install grout in accordance with recommendations provided by grout manufacturers.

About the cover:

Project

The Maritime Hotel

New York, NY

Architects

BD Stanhope LLC

Chicago, IL

Photographer

© Gregory Goode